

研究目的と要素技術

物・食品, 労働力, 時間,
エネルギーの

Waste

無線, センシング,
ソフトウェアなど

ICT活用による解決

幸福で安心・
安全な暮らし
が持続可能な
社会の実現

Wireless systems
Antenna systems
Sensors
Software

IoT
Internet of Things

バッテリーレス無線振動センサのデモ

B. Rahmadya, X. Chen, S. Takeda, K. Kagoshima, M. Umehira and W. Kurosaki, "Measurement of a UHF RFID-based battery-less vibration frequency sensitive sensor tag using tilt/vibration switches," IEEE Sensors Journal, vol. 20, no. 17, pp. 9901-9909, Sept. 2020.

IoT

Internet of Things

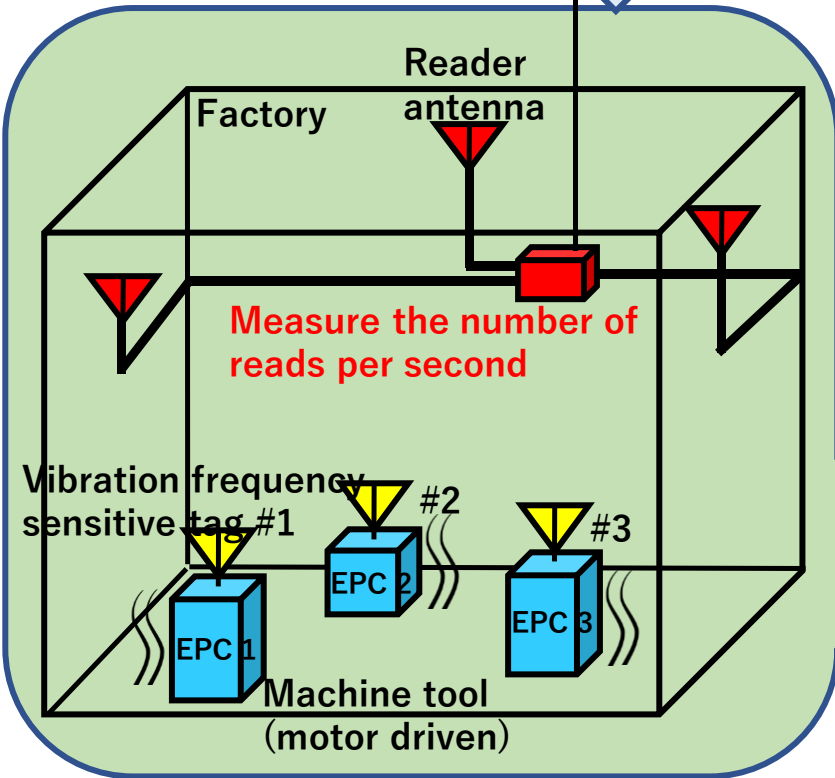
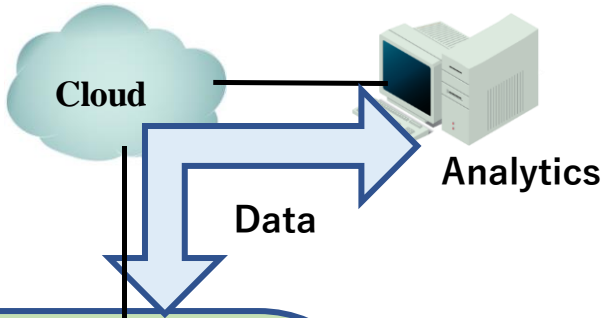

機器の状態監視による
故障診断，長寿命化

Factory

バッテリーレス無線振動センサのデモ

Passive vibration frequency sensitive tag

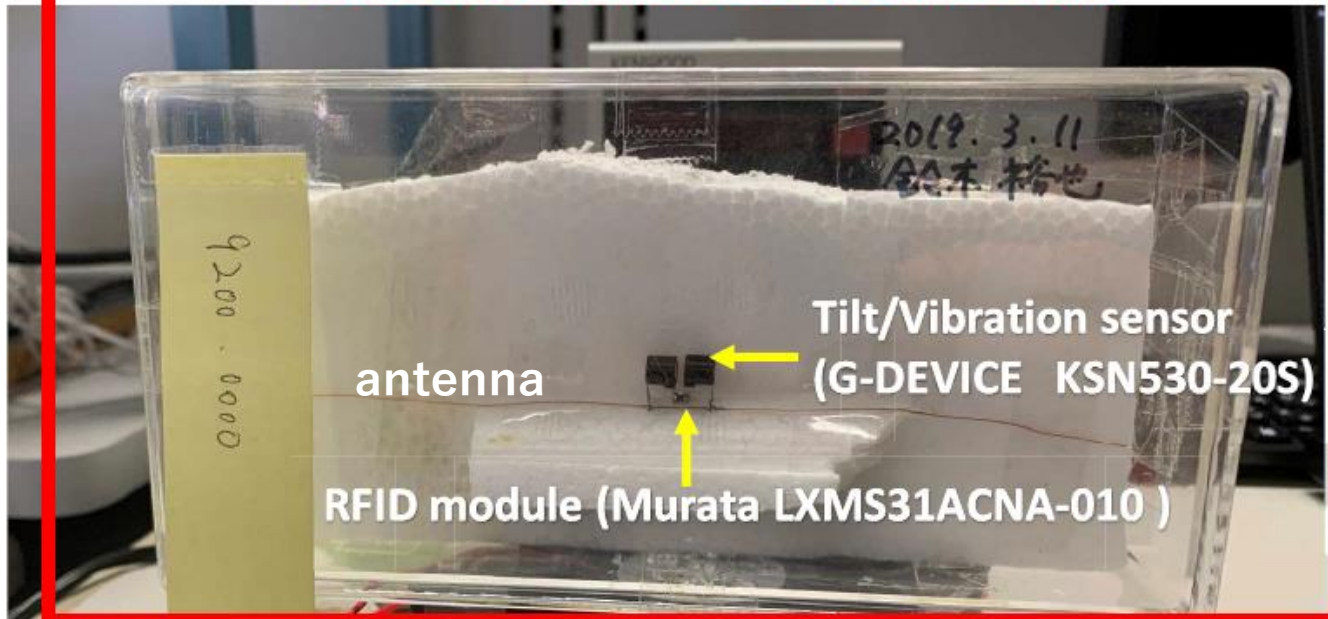

Vibration
generator
(cooling fan)

Scotch tape

Wooden board

Foam polystyrene

バッテリーレス無線振動センサのデモ

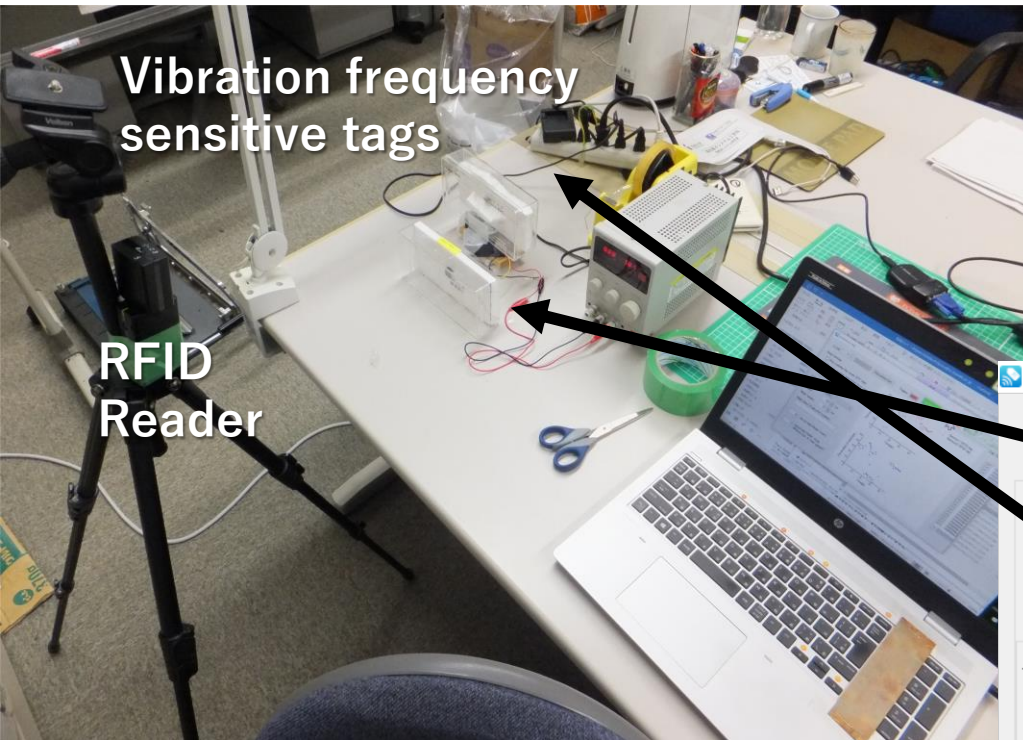

パソコン用冷却ファンのような微弱振動の強弱をバッテリーレス検出

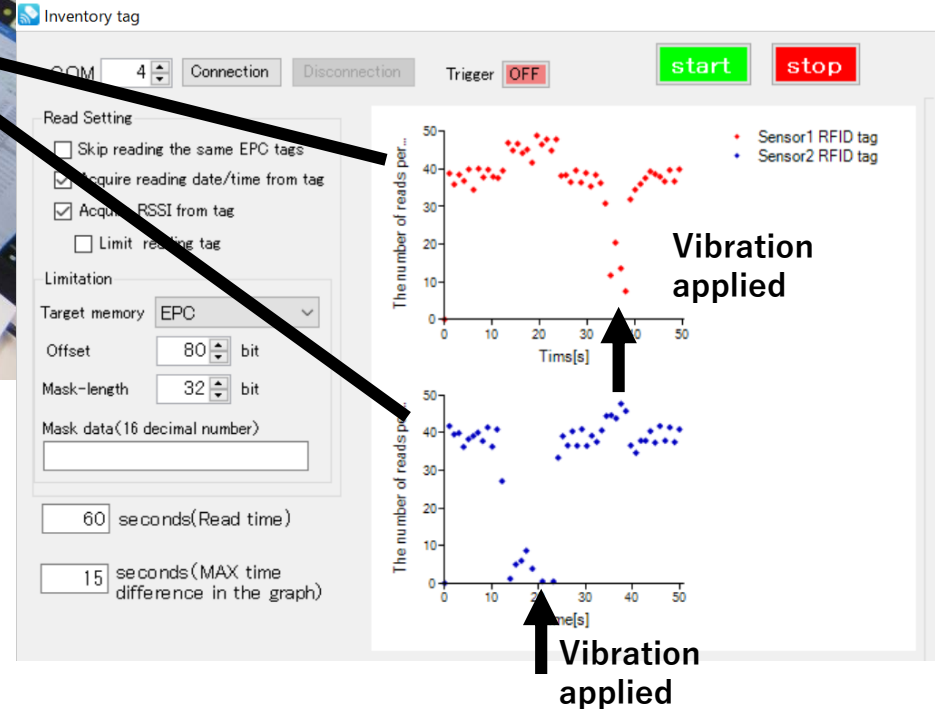

バッテリーレス無線振動センサのデモ

COM
Connection
Disconnection
Trigger
start
stop

Read Setting

Skip reading the same EPC tags

Acquire reading date/time from tag

Acquire RSSI from tag

Limit reading tag

Limitation

Target memory

Offset bit

Mask-length bit

Mask data(16 decimal number)

seconds(Read time)

seconds(MAX time difference in the graph)

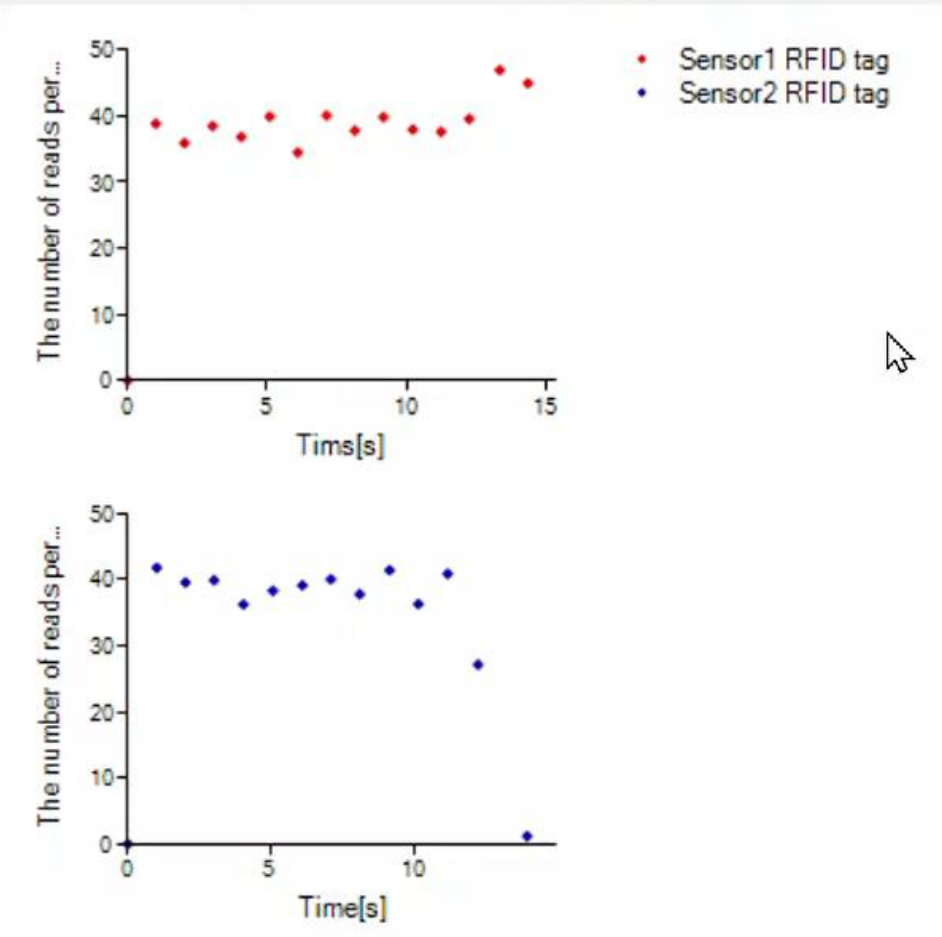

The number of reads per...

Times[s]

The number of reads per...

Time[s]

色変化RFIDタグのデモ

B. Rahmadya, J. Wang, F. Kong, S. Takeda, K. Kagoshima, and M. Umehira, "Ultra-High Frequency Band Radio Frequency Identification Tag Enabling Color-Change for Inventory Management Systems: a Color-Change Tag," IEEE Journal of Radio Frequency Identification, vol.4., Issue 2 , pp.101-106, June 2020.

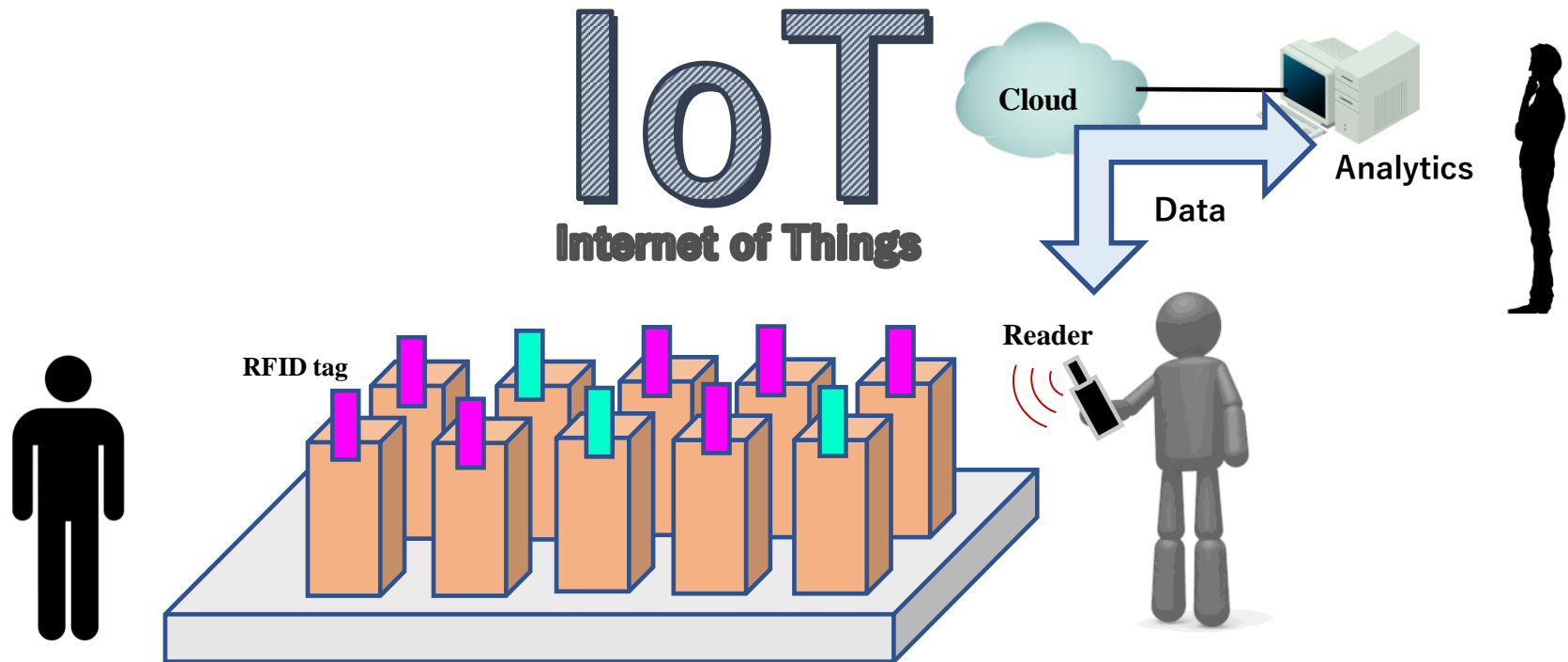

- 内部メモリ状態を可視化できない RFIDタグの持つ欠点を克服
- 期限切れ, 処理済みの可視化

色変化RFIDタグのデモ

- 通常、可視化に利用されるLEDよりも2桁程度低い電力で可視化可能
- さらに可視化結果を保持

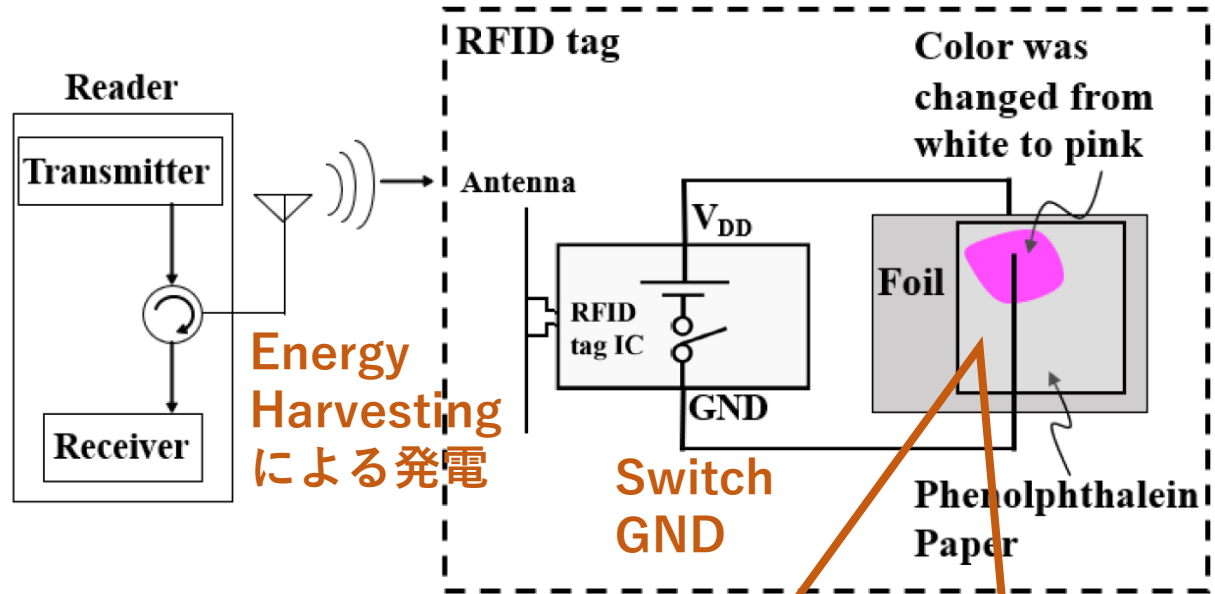

色変化RFIDタグのフレームワーク

色変化RFIDタグのデモ



光無線通信のデモ

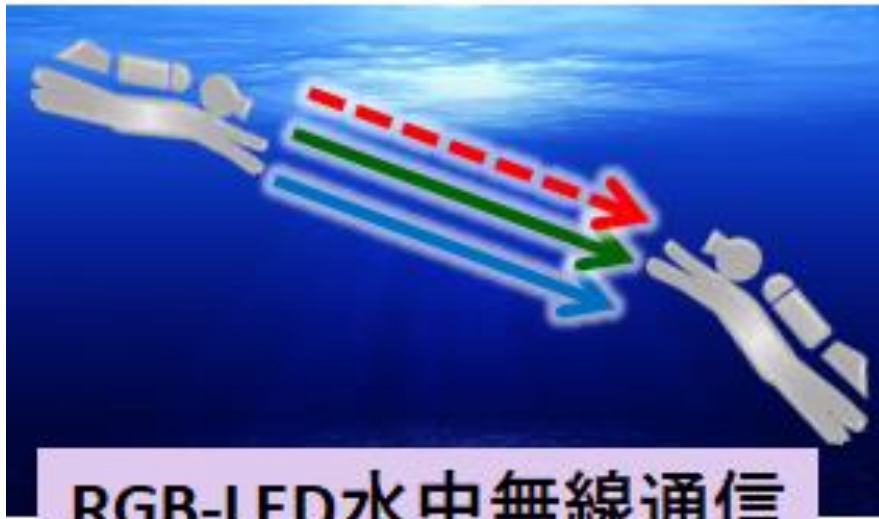

電波よりも水中で伝搬しやすい光を利用した水中無線通信

RGB-LED水中無線通信

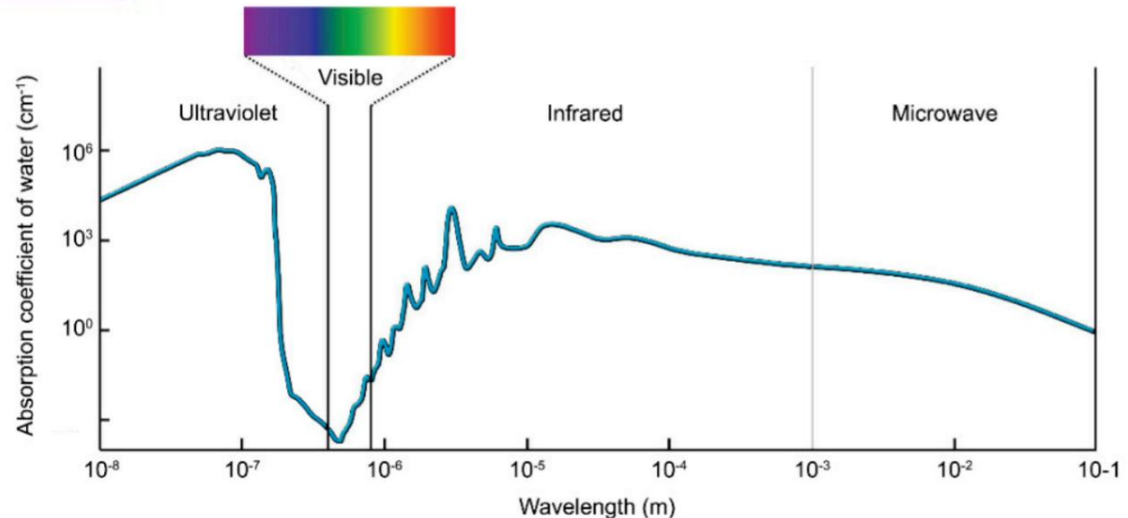

光無線通信のデモ

実験装置

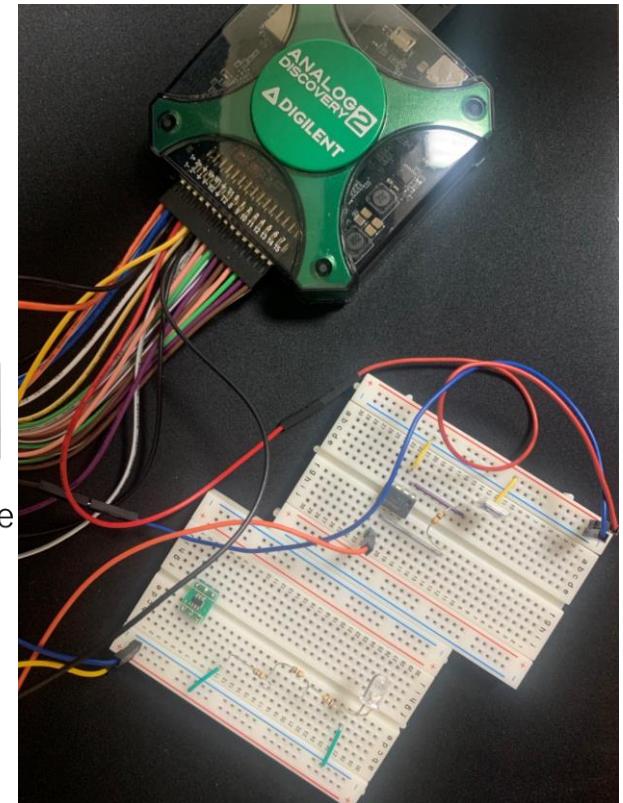
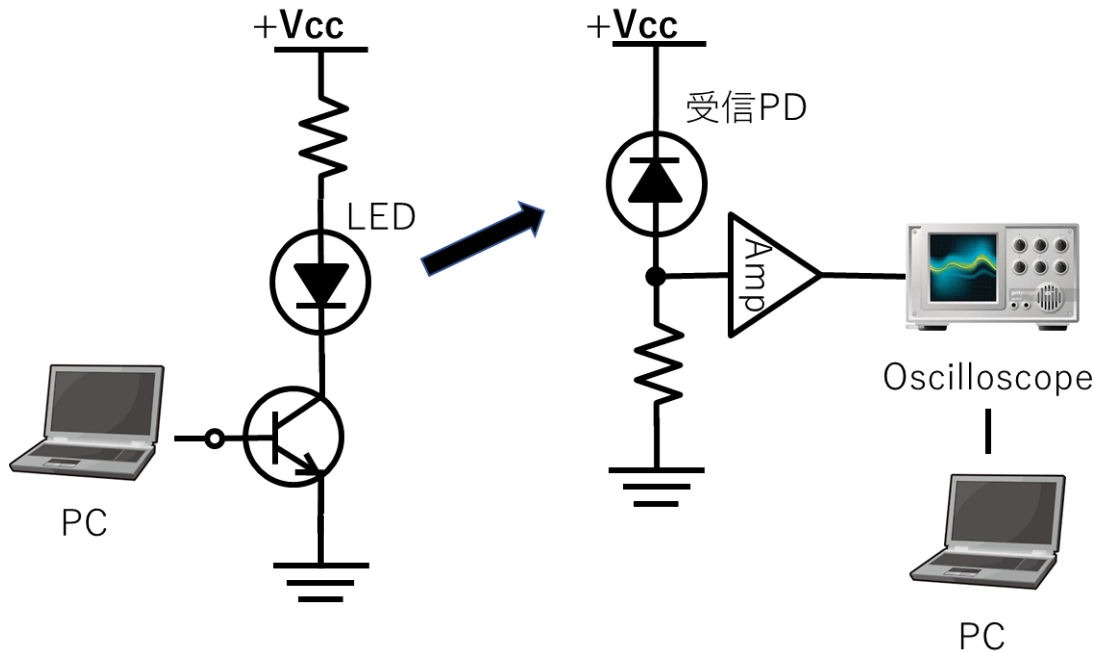

LEDの点滅(ON, OFF)を利用した可視光データ通信

光無線通信のデモ

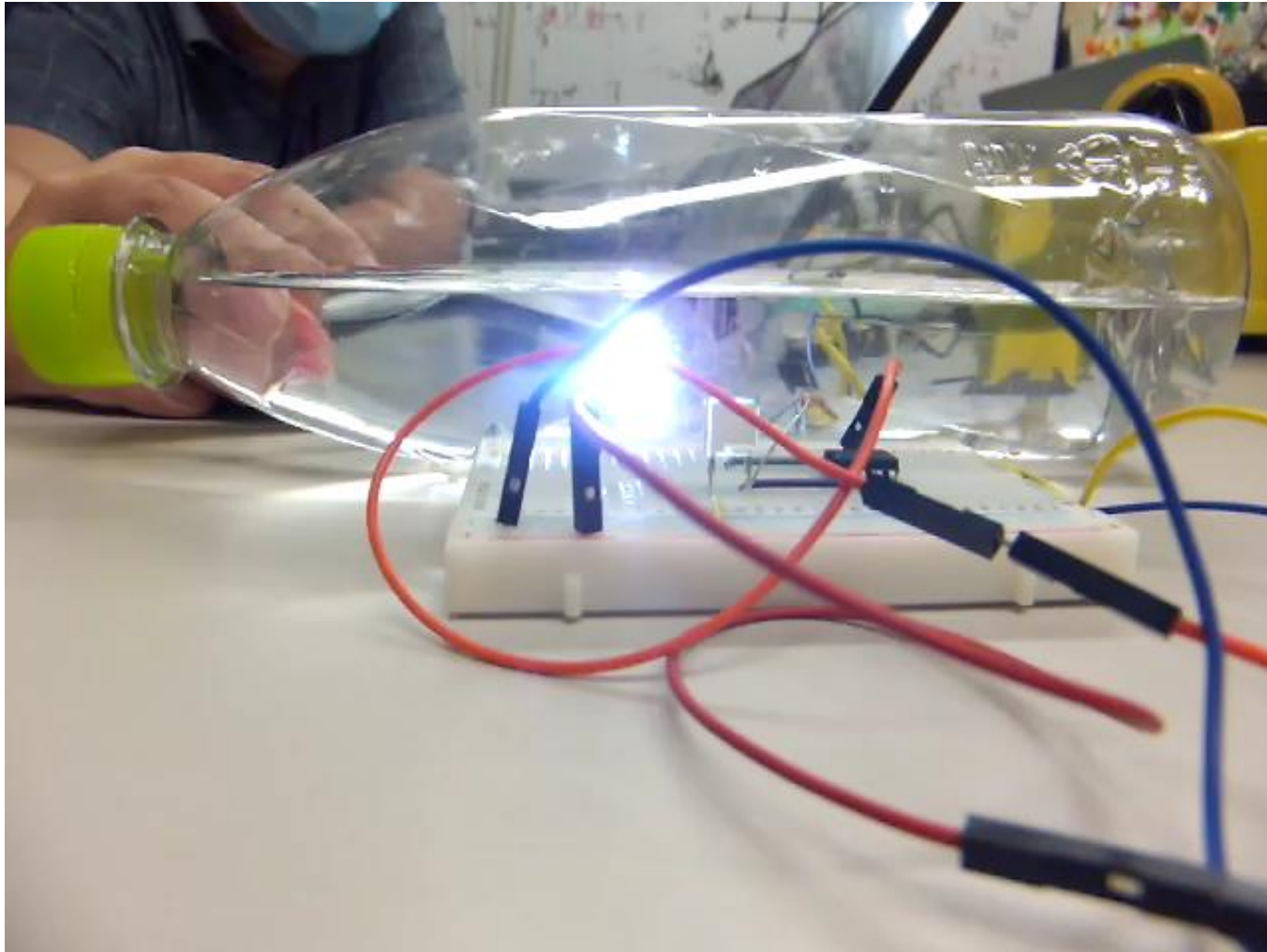

光無線通信のデモ



自動車用センサ

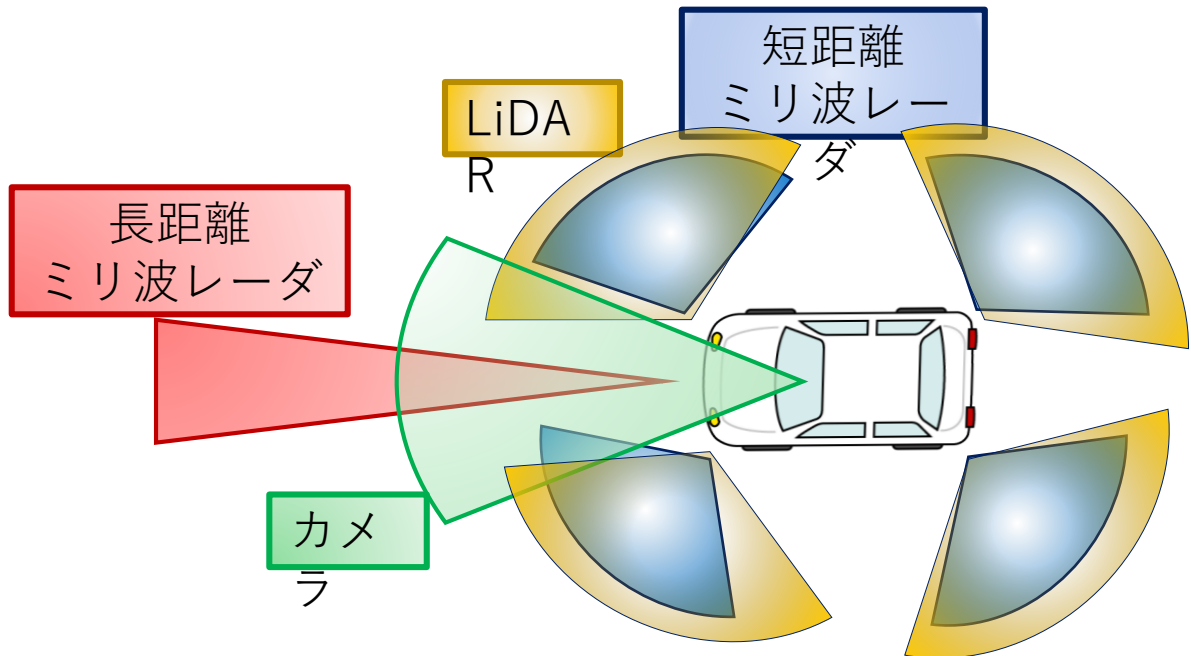
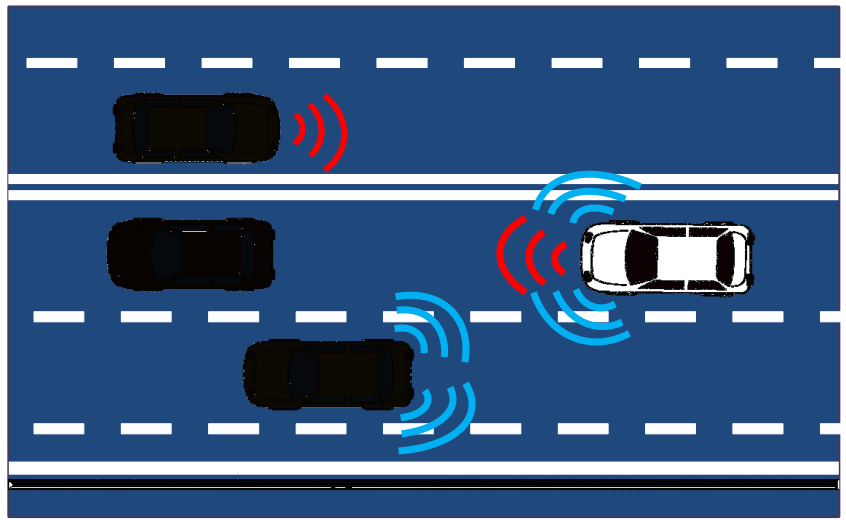

受信アレーアンテナの仮想的拡張法(線形予測法の適用)

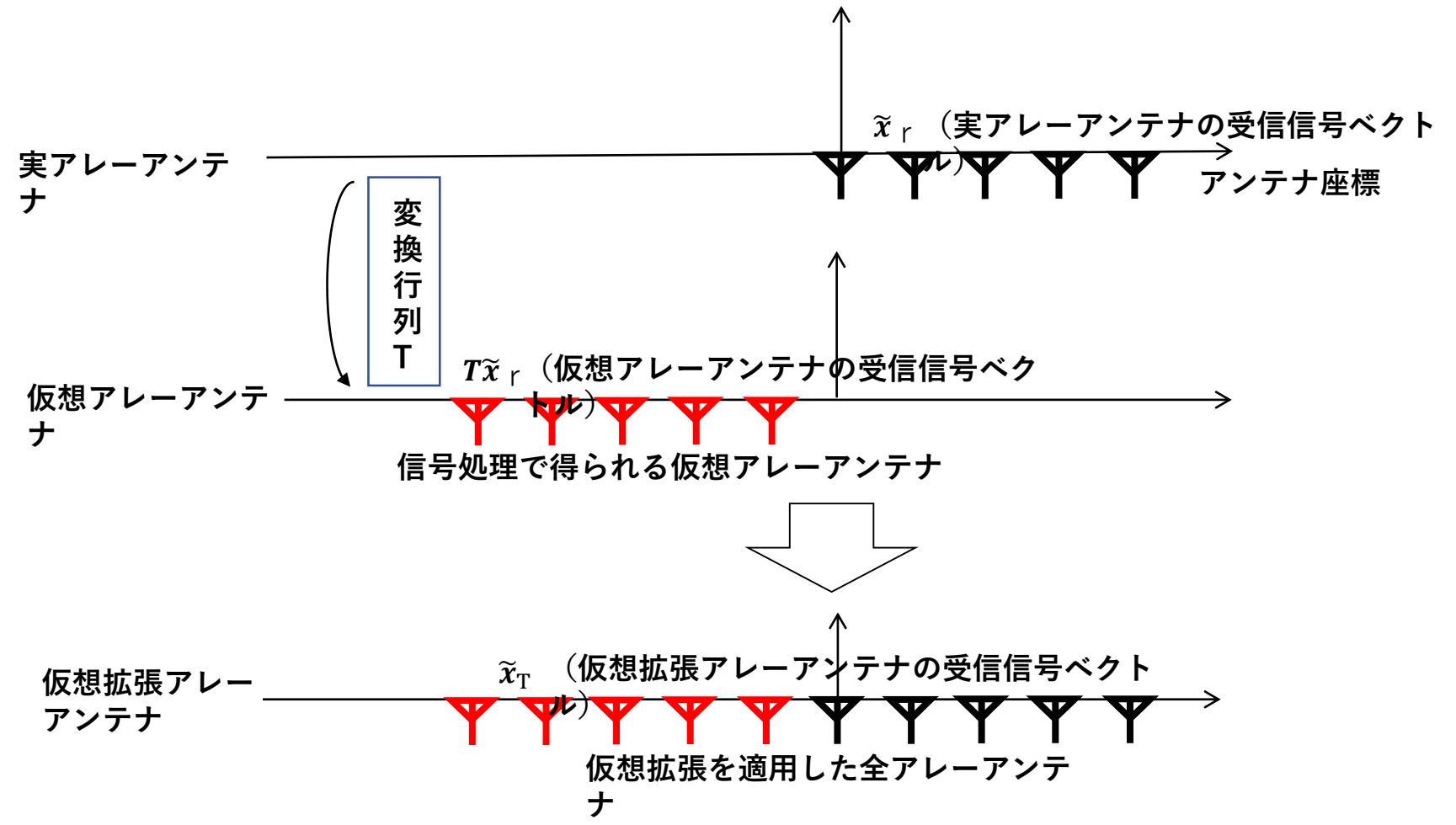

受信アレーアンテナの仮想的拡張法(線形予測法の適用)



受信アレーアンテナの仮想的拡張法(線形予測法の適用)

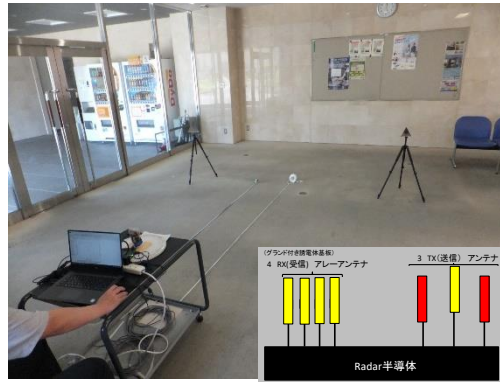

ターゲット角度: **-5.71** , **+5.71**

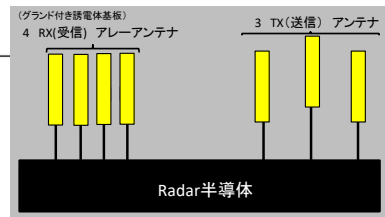
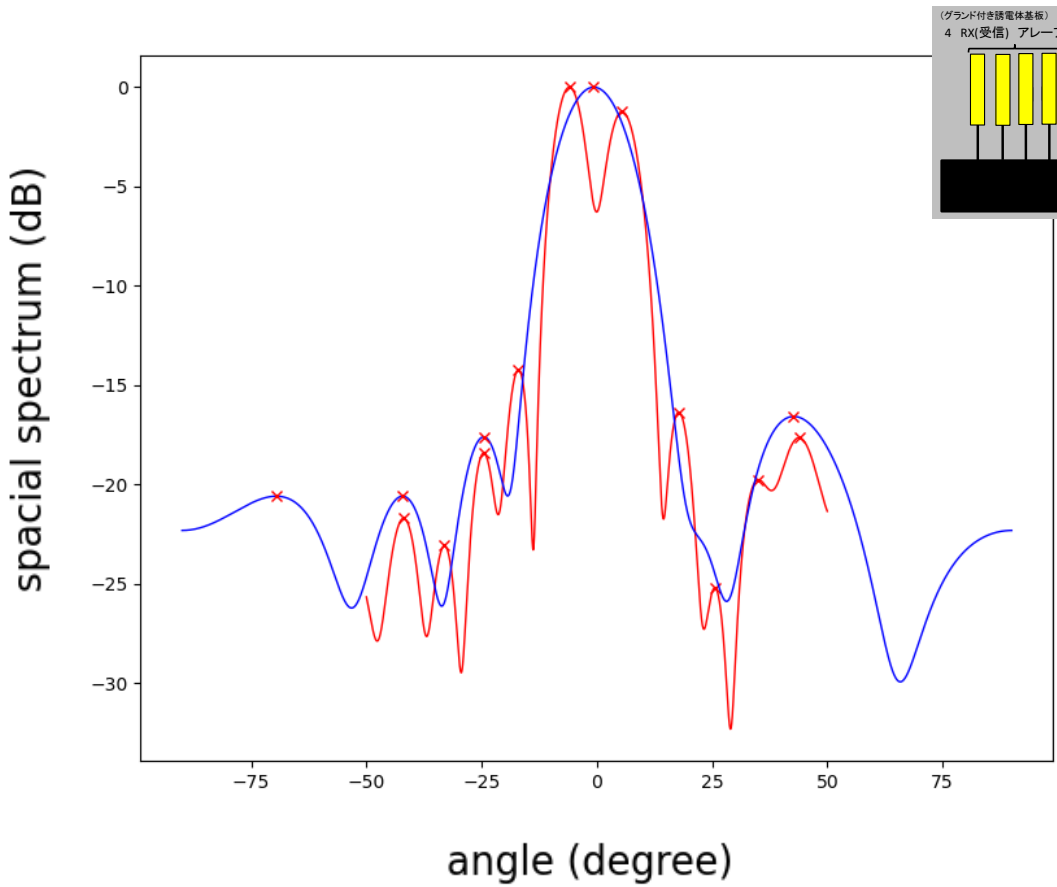
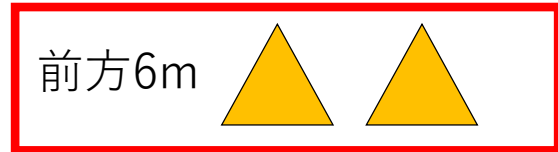

仮想拡張処理なし

-0.67

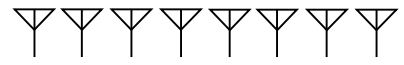

仮想拡張処理あり

-5.96
5.48



但し、MIMOレーダーと仮想拡張を組み合わせるために、特別な前処理を適用している